

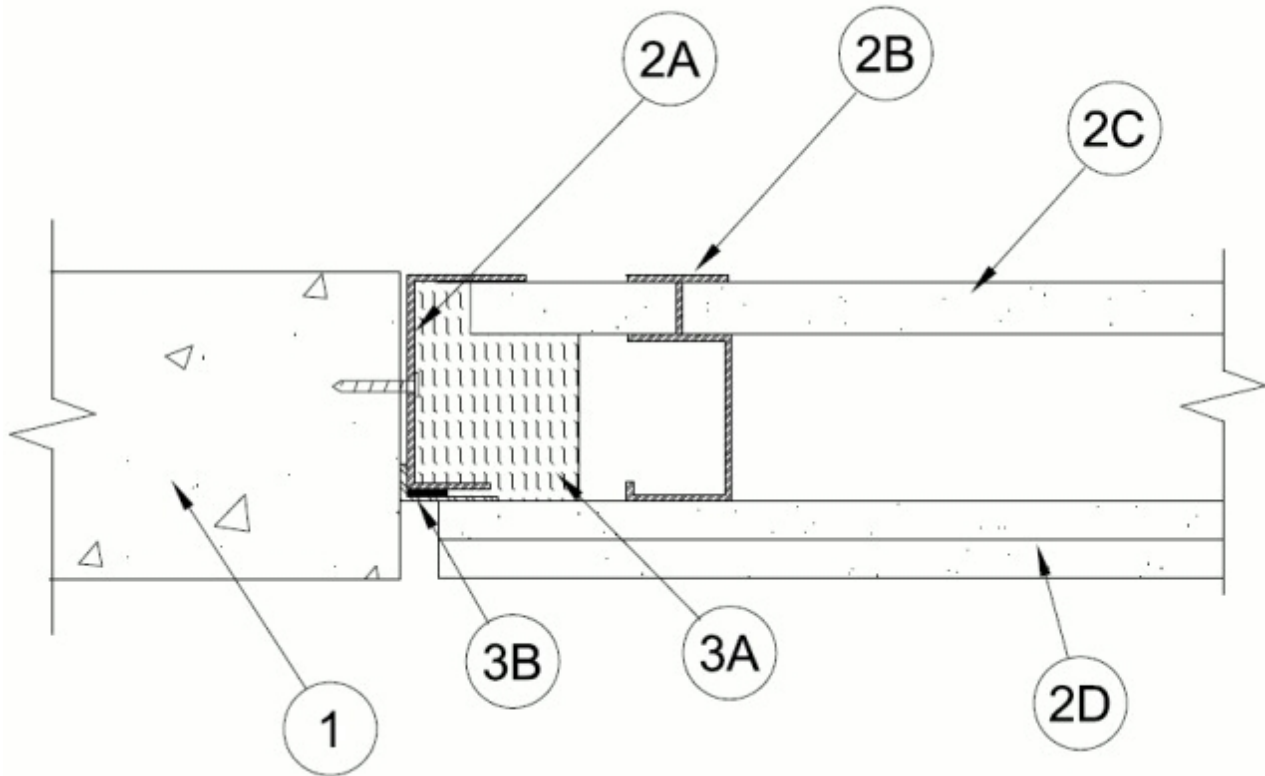

System No. WW-D-0163

October 24, 2013

ANSI/UL2079	CAN/ULC S115
Assembly Rating — 1 and 2 Hr (See Item 2)	F Rating — 1 and 2 Hr (See Item 2)
Nominal Joint Width - 3/8 in.	FT Rating — 1 and 2 Hr (See Item 2)
Class II and III Movement Capabilities — 100% Compression or Extension	FH Rating — 1 and 2 Hr (See Item 2)
L Rating at Ambient — Less than 1 CFM/Lin Ft	FTH Rating — 1 and 2 Hr (See Item 2)
L Rating at 400°F — Less than 1 CFM/Lin Ft	Nominal Joint Width - 3/8 in.
	Class II and III Movement Capabilities — 100% Compression or Extension
	L Rating at Ambient — Less than 1 CFM/Lin Ft
	L Rating at 400°F — Less than 1 CFM/Lin Ft



1. **Concrete Wall Assembly** — Min 5-1/4 in. (133 mm) thick reinforced lightweight or normal weight (100-150 pcf or 1600-2400 kg/m³) structural concrete. Wall may also be constructed of any UL Classified **Concrete Blocks***.

See **Concrete Blocks** (CAZT) category in the Fire Resistance Directory for names of manufacturers.

2. **Gypsum Wall Assembly** — The 1 or 2 h fire-rated gypsum board/steel stud wall assembly shall be constructed of the materials and in the manner specified in the individual U400, V400 or W400 Series Wall and Partition Design in the UL Fire Resistance Directory. The wall shall include the following construction features:

A. **Steel Runners** — "J"-shaped runners, min 4 in. (102 mm) wide with unequal legs of min 1 in. (25 mm) and min 2 in. (51 mm), fabricated from min 24 MSG galv steel. Runners installed with short leg toward finished side of wall. Runners secured to concrete wall assembly with steel masonry fasteners spaced 12 in. (305 mm) OC.

B. **Studs** — "C-T", "I", or "C-H" shaped steel studs to be min 4 in. (102 mm) wide and formed of min 25 ga galv steel. First stud adjacent to concrete wall assembly located max 4 in. (102 mm) from wall face. Stud spacing not to exceed 24 in. (610 mm) OC.

C. **Gypsum Board*** — 1 in. (25 mm) thick by max 24 in. (610 mm) wide gypsum board liner panels installed as specified in the individual Wall and Partition Design except that a max 1 in. (25 mm) gap shall be maintained between the side of gypsum board and steel runner (Item 2A). Vertical edges inserted into "T" shaped section of "C-T" studs, into holding tabs of "I" studs or into "H"-shaped section of "C-H" studs.

D. **Gypsum Board*** — Gypsum board 5/8 in. (16 mm) thick, applied on finished side of wall as specified in the individual Wall and Partition Design except that a max 3/8 in. (9.5 mm) gap shall be maintained between the side of gypsum board and face of concrete wall. The screws attaching the gypsum board to the first stud shall be located max 4 in. (102 mm) from face of concrete wall assembly. Gypsum board not attached to side runner.

The hourly fire rating and the F, FT, FH and FTH ratings of the joint system is equal to the hourly fire rating of the wall.

3. Joint System — Max separation between side of gypsum board on finished side of wall and face of concrete wall assembly (at time of installation) is 3/8 in. (9.5 mm). The joint system is designed to accommodate a max 100 percent compression or extension from its installed width.

A. **Forming Material*** — Min 3 in. thickness of min 4 pcf (64 kg/m³) mineral wool batt insulation cut to width of runner, compressed min 25 percent in width and friction fit into side runner of gypsum wall assembly between leg of track and gypsum liner board.

See **Forming Material** (XHKU) category in the Fire Resistance Directory for names of manufacturers.

B. **Fill, Void or Cavity Material*** — Min 25 ga composite steel angle with one 5/8 in. (16 mm) leg and one 1-1/2 in (38 mm) leg with an intumescent strip affixed along the inside 1-1/2 in (38 mm) leg. The 5/8 in. leg of steel angle is friction fit between the web of the side runner (Item 2A) and the concrete wall. Steel angle is required on one side of wall only (either side).

RECTORSEAL — Track Safe

*Bearing the UL Classification Mark